

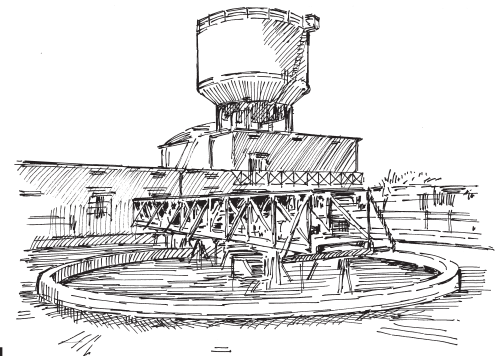

Rehabilitating water treatment works after an emergency

In urban areas, the population may be entirely reliant on the public water supply system for their drinking-water. Modern water treatment works rely on the inputs of skilled operators as well as supplies of chemicals, electricity and machinery. A disaster can cause extensive damage to the works leading to a reduced or even a total loss of output. This technical note identifies the first steps to take towards rehabilitating a water treatment works after an emergency. Details of the rehabilitation of smaller systems are given in Technical Note 4.



Steps for rehabilitation

In an emergency, the primary goal of rehabilitating a water treatment works is to maximize the quantity of water produced. This is followed by the gradual, step-by-step improvement in water quality. Most water treatment works are connected to a piped distribution system. This, too, needs to be rehabilitated if the treated water is to reach the consumer. Details of the rehabilitation of distribution systems are given in Technical Note 4.

Assess the situation

Identify key workers

Identify local water treatment operators who understand the system. They can provide knowledge of the works and the sources of supply. Often, however, operators do not fully understand the treatment process, so try to identify professional engineers, scientists and managers who do. Note that you may have to pay operators and managers if the emergency has interrupted their salary payments.

Understand the process

In order to rehabilitate the water treatment plant it is important to

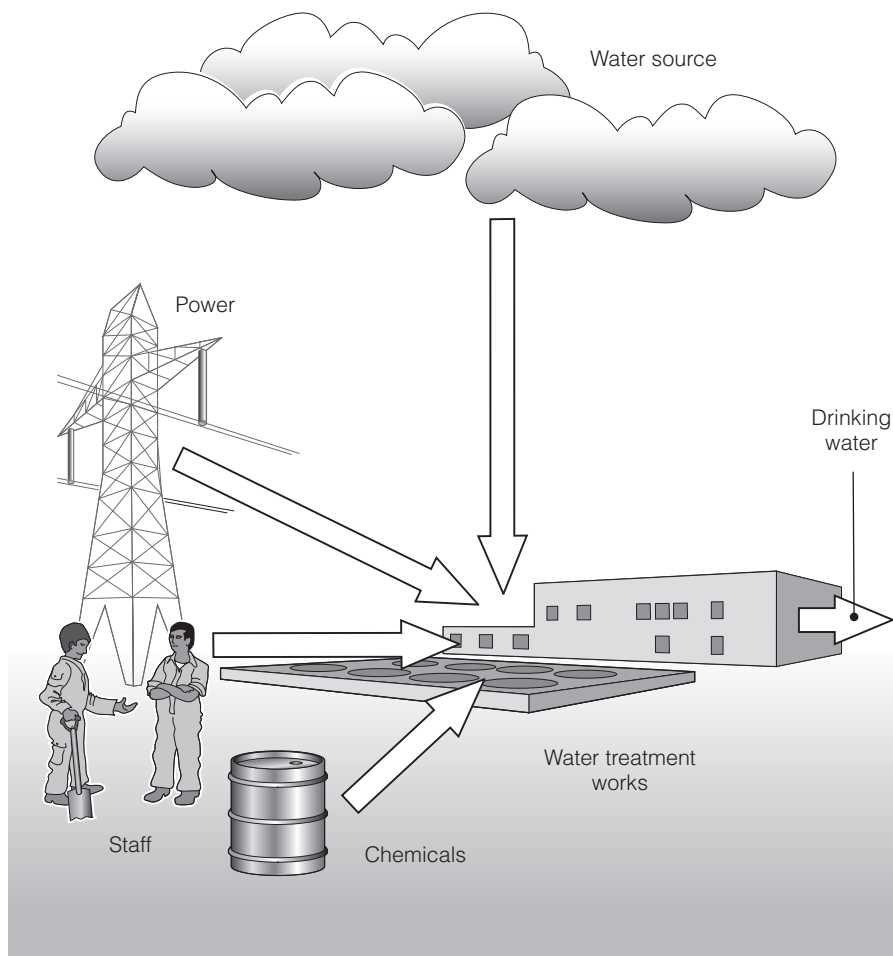

Figure 6.1. Modern water treatment works rely on the inputs of skilled operators as well as supplies of chemicals, electricity and machinery that functions reliably

understand how it works. Individual plants will vary in design, but most are based on a sequence of processes that fit together to improve the quality of water in incremental steps. Figure 6.3 shows the principal processes. Not all processes shown will operate in every case. In some cases the order in which they take place will differ.

Assess the condition of the plant

The condition of each plant component will need to be assessed. Identify which components are working, which could be repaired and which will have to be replaced. Repair and renovation is generally quicker than replacement, particularly if skilled workers are available locally. Be aware that damaged components may not necessarily be related to the disaster. Chronic underfunding and lack of skilled workers is a common problem in the water industry, so treatment plants frequently do not function correctly, not only during emergencies.

Decide what to do first

The first requirement is to get water into the distribution system quickly. Water quantity (rather than quality) provides the main health and social benefits during an emergency. Treatment, therefore, can be limited in the first instance, but ensure that the water is free of gross contaminants that may block or damage pipes and pumps.

Preventing pollution

The first step in improving water quality is to reduce the need for treatment by minimizing the level of pollution at source. Providing environmental sanitation services (such as the management and disposal of excreta, solid waste and rainwater), controlling erosion, reducing agricultural pollution and restricting direct public access to the water source can reduce the amount of contaminants that have to be removed from the water (Figure 6.2). In many cases, restoring a sewage

collection and treatment system may be a greater priority than completely rehabilitating the water treatment works.

Staged rehabilitation

The priority for treatment works rehabilitation is shown in Figure 6.4 overleaf. If, however, the water is relatively clear, chlorination can be introduced at an earlier stage. This may involve the installation of temporary pipelines to bypass damaged sections of the plant. If major components of the works such as storage reservoirs and sedimentation tanks are badly damaged, their repair or replacement will be expensive and take a long time. During the emergency phase they should be replaced with temporary equipment such as portable storage tanks.

Pumps and power

Pumps (and the motors that drive them) are essential components of many treatment works. They have a variety of uses such as raising water from the intake into the works, between different elements in the works, or for adding and mixing chemicals. It will be essential to the overall operation of the works that they function well, so their rehabilitation must be a priority. Replacement parts may take time

to be delivered, so ask an engineer to make an early assessment of the state of the pumps.

Power is also essential and an additional priority. If the mains supply is not working, install mobile generators.

Works operation

As soon as components of the treatment works have been re-commissioned, their operation will need to be sustained. This will include:

- **Monitoring:** The quality and quantity of water being produced by the works should be measured regularly to check whether everything is working correctly and that the output meets minimum standards (see the Sphere Guidelines for minimum standards for emergency water supplies). Simple test kits are available for measuring basic parameters of water quality. Sources of further information are given on page 6.4.
- **Chemicals:** Modern treatment works rely on the addition of chemicals to aid the treatment process. These include *alum* to help settlement, *lime* for

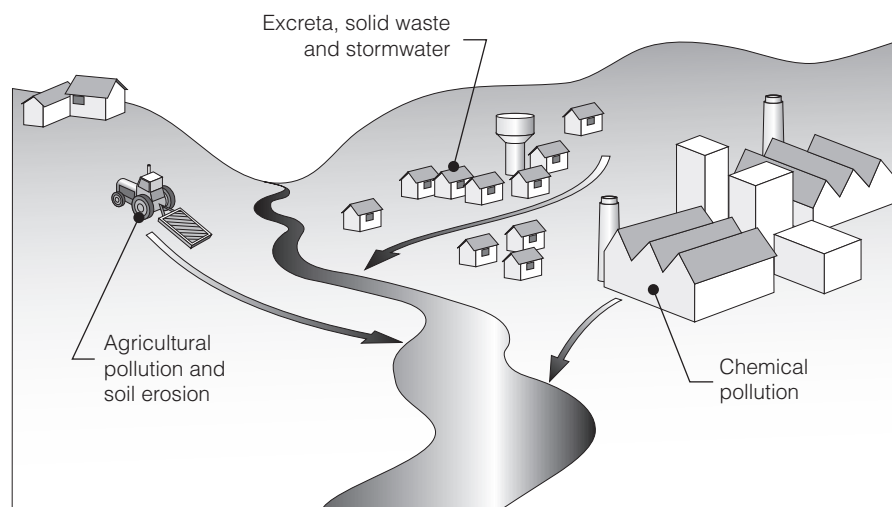
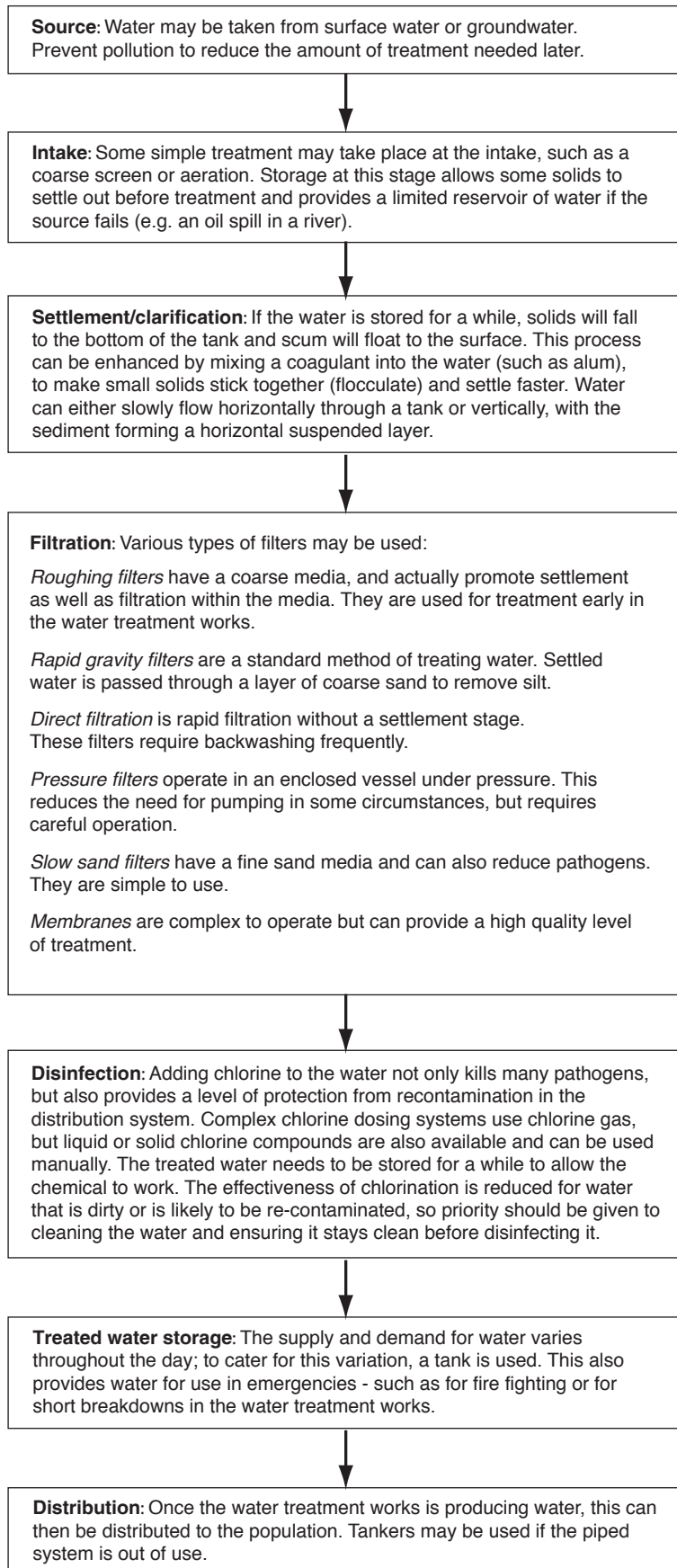
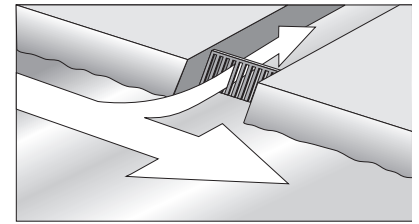

Figure 6.2. Preventing pollution upstream as shown will reduce the need for treatment

Rehabilitating water treatment works after an emergency



Intake



Sedimentation

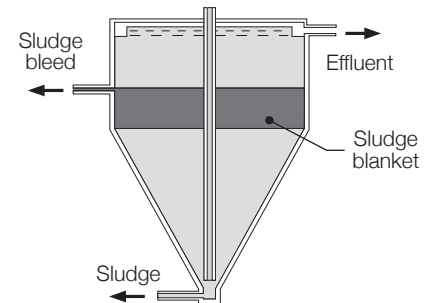

Filtration

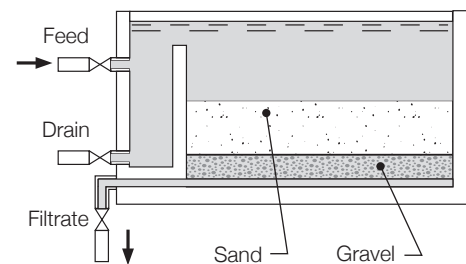

Disinfection

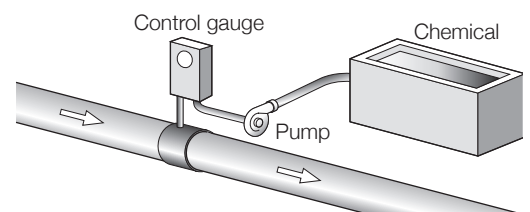

Storage

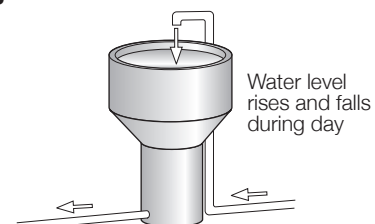

Figure 6.3. Overview of a water treatment and supply system

Rehabilitating water treatment works after an emergency

adjusting the pH of the water and *chlorine* for disinfection. It may take a long time to replenish supplies so the need for chemicals should be identified and suppliers contacted as soon as possible. A reduced level of treatment can be provided if chemicals are in short supply, using point of use disinfection where it is most needed, such as in hospitals and schools.

- **Maintenance:** This includes manual tasks, such as cleaning screens, removing settled sludge and lubricating pumps. The filters will become clogged with solids. Pipes will need to be checked for leaks.

Public information

The public should be kept informed of developments. This will ease concerns about water availability and help to reduce wastage, particularly if the public can help identify leaks in the distribution system.

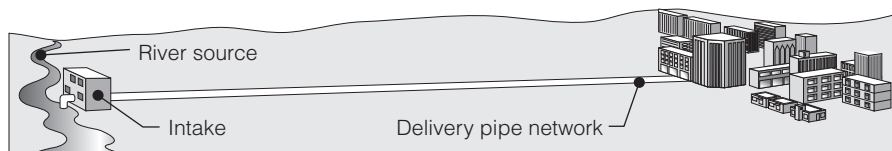

Water intake and delivery pipe network

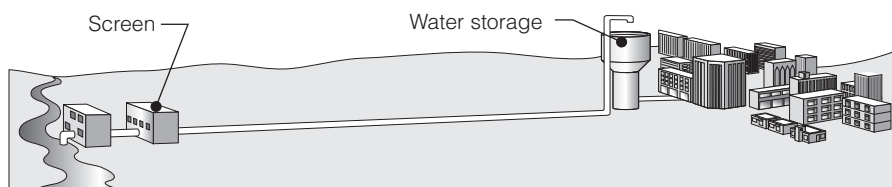

Primary screening

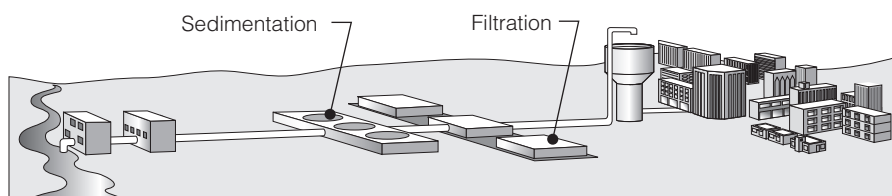

Sedimentation and filtration

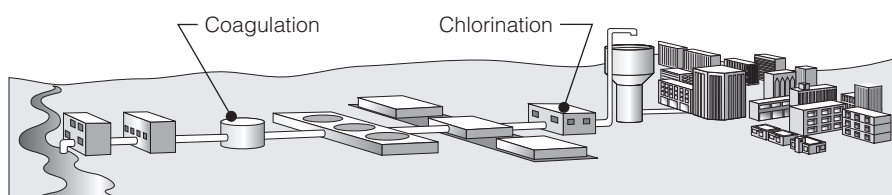

Coagulation and chlorination

Figure 6.4. Water treatment in stages

Further information

Le Chevallier, M.W. and Au, K.K. (2004) *Water Treatment and Pathogen Control: Process efficiency in achieving safe drinking water*, WHO/IWA Publishing at: http://www.who.int/water_sanitation_health/dwq/9241562552/en/index.html

Twort, A.C. et al. (2000) *Water Supply*, 5th ed. Arnold with IWA Publishing: London
Sphere (2004). *Humanitarian Charter and Minimum Standards in Disaster Response*, The Sphere Project: Geneva, Switzerland (Distributed worldwide by Oxfam GB) <http://www.sphereproject.org/>



World Health Organization

Water, Sanitation,
Hygiene and Health Unit
Avenue Appia 20
1211 Geneva 27
Switzerland

Telephone: + 41 22 791 2111
Telephone (direct): + 41 22 791 3555/3590
Fax (direct): + 41 22 791 4159
URL: www.who.int/water_sanitation_health

Prepared for WHO by WEDC. Authors: Brian Reed and Bob Reed. Series Editor: Bob Reed.

Editorial contributions, design and illustrations by Rod Shaw

Line illustrations courtesy of WEDC / IFRC. Additional graphics by Ken Chatterton.

Water, Engineering and Development Centre Loughborough University Leicestershire LE11 3TU UK
T: +44 1509 222885 F: +44 1509 211079 E: wedc@lboro.ac.uk W: <http://wedc.lboro.ac.uk>

