

23. A guide to sanitation selection

Drawings 1-6 illustrate the principal options for on-site sanitation. The *Guide to Sanitation Selection* on the centre pages may be used to determine which option is likely to be most effective according to the method of anal cleansing, water availability and willingness to pay.

1. Single pit sealed lid

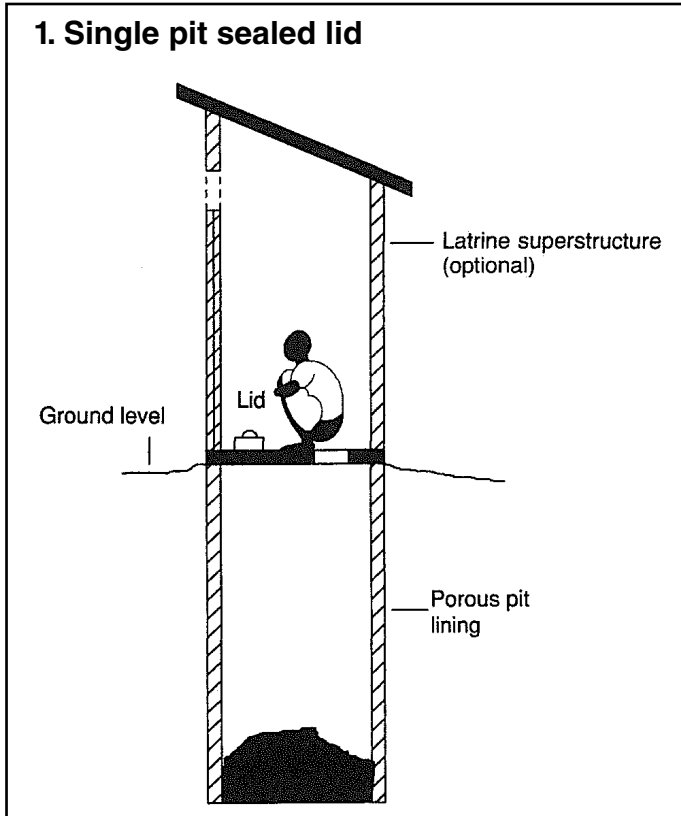

2. Single pit ventilated

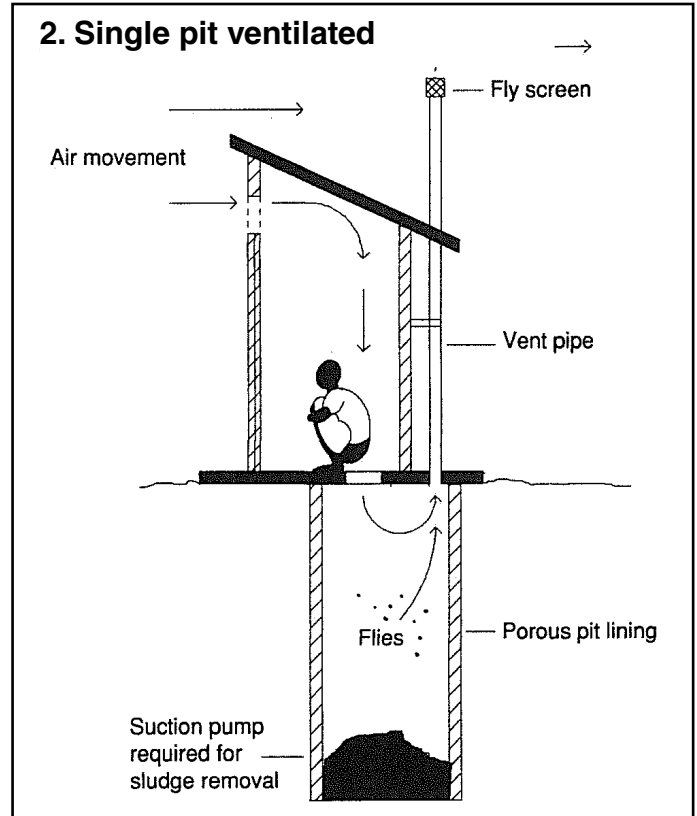

3. Twin pit ventilated

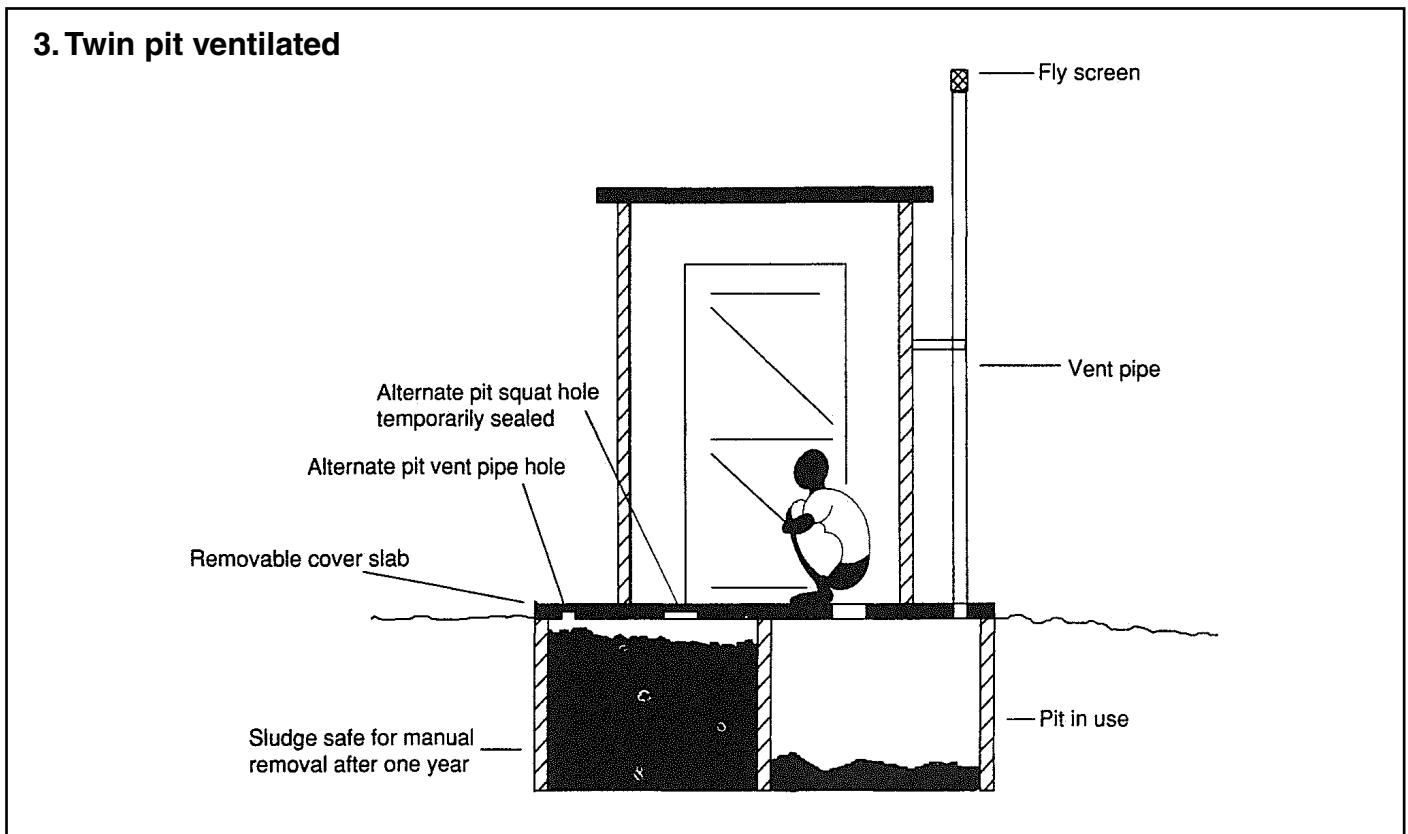

A guide to sanitation selection

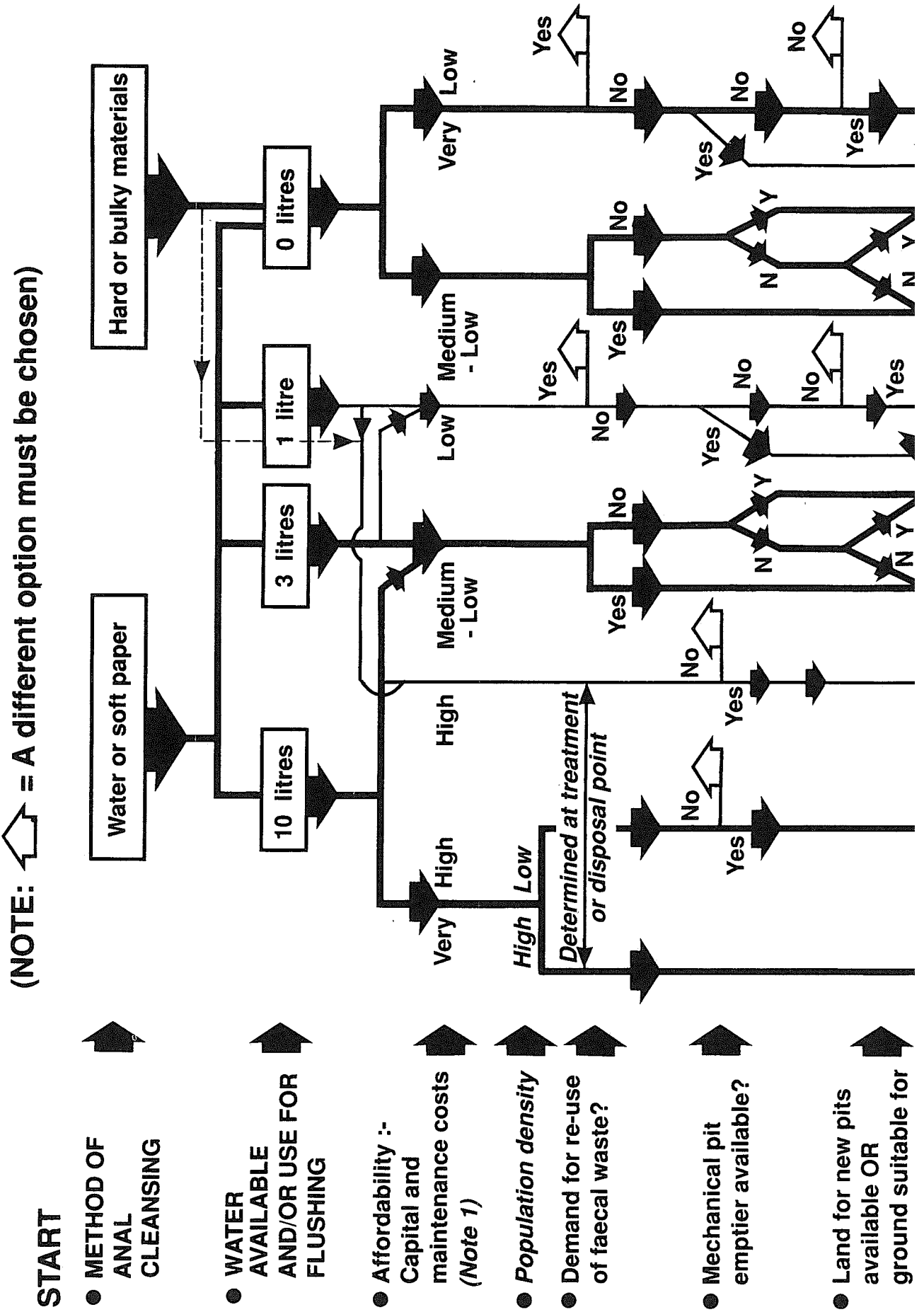

A guide to sanitation selection

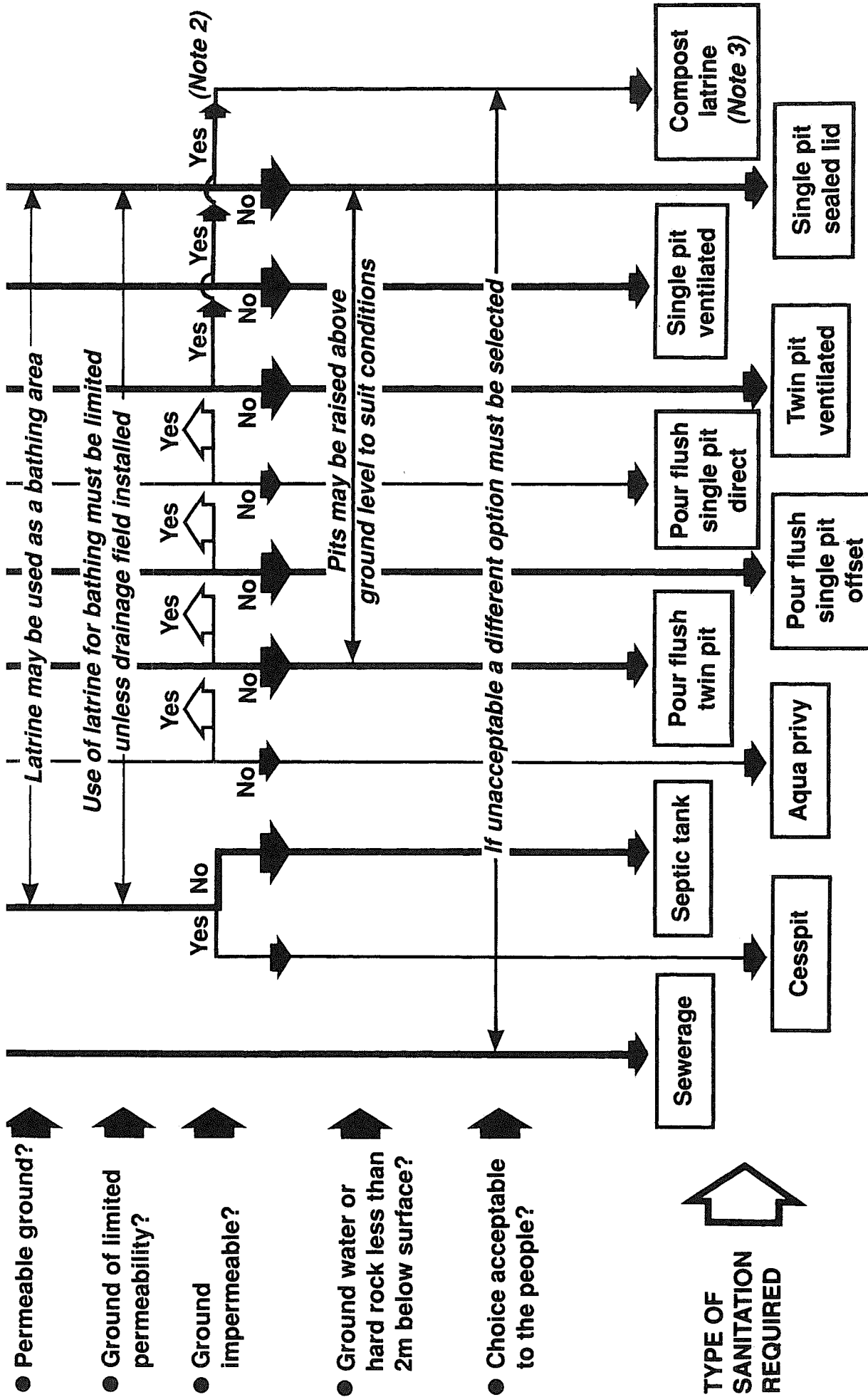

Note 1: Not all possibilities are illustrated as it is assumed that water availability is related to affordability

Note 2: Use extra large pits or consider composting

Note 3: Also dependent on willingness to collect urine separately, demand for compost, availability of ash or vegetable matter etc.

A guide to sanitation selection

4. Pour flush single pit offset

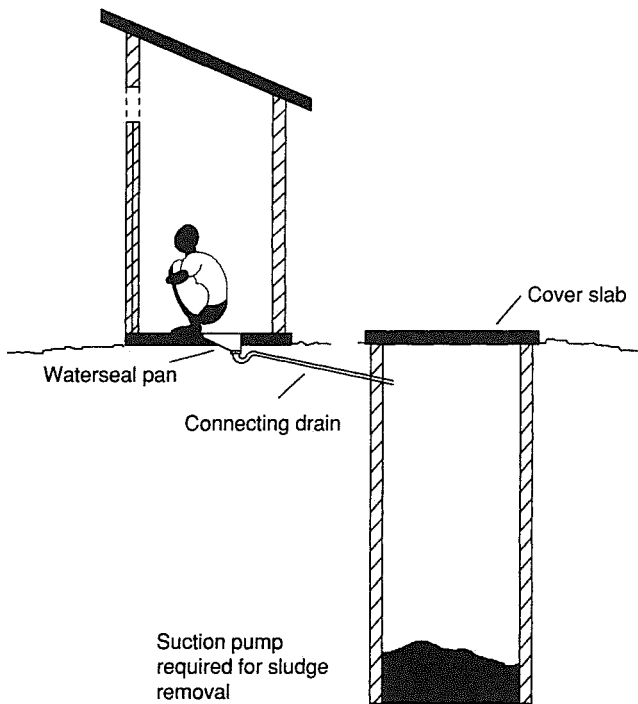

5. Pour flush twin pit

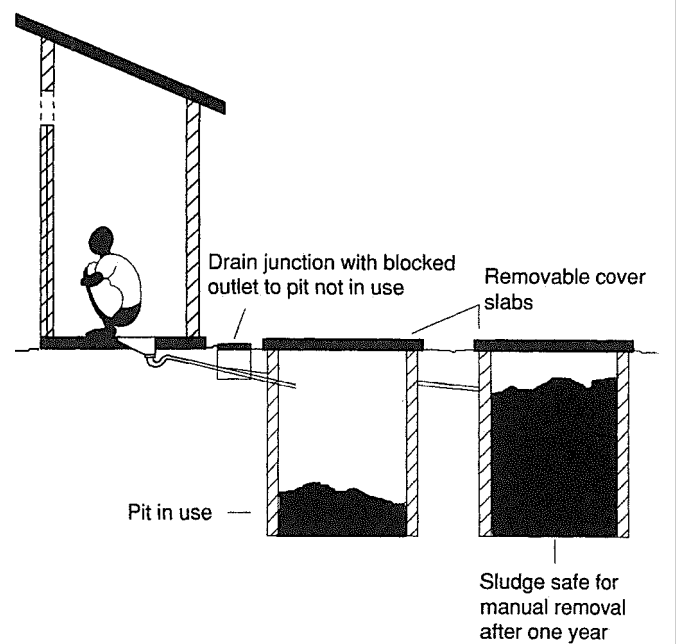

6. Septic tank

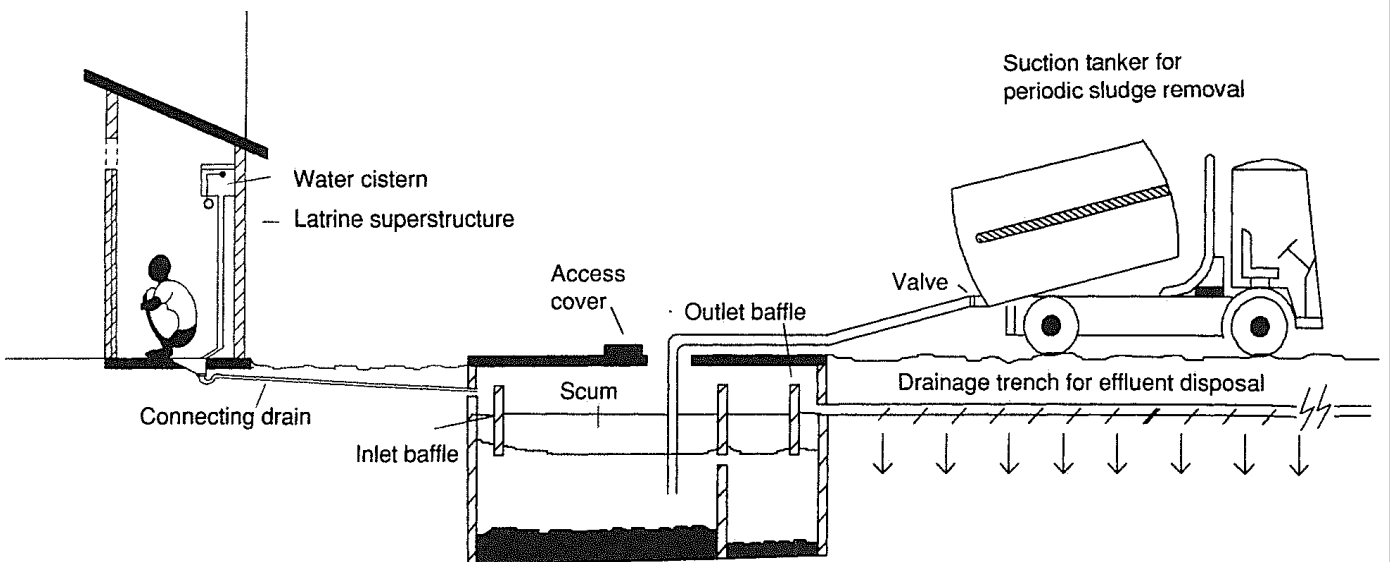

Note: In all systems, seats may be used as an alternative to squatting

For further information:

Franceys, Pickford, Reed, *On-Site Sanitation*, WHO 1991.

Text and design: Richard Franceys

Illustrations: Rod Shaw

WEDC, Loughborough University of Technology, Loughborough, Leicestershire LE11 3TU, UK.